

plastic and
pool products

oku[®]
Obermaier GmbH

OKU Holzpool EMOTION-FUN

Rund 4,10 m

Höhe 1,18 m

44mm

+/-1mm

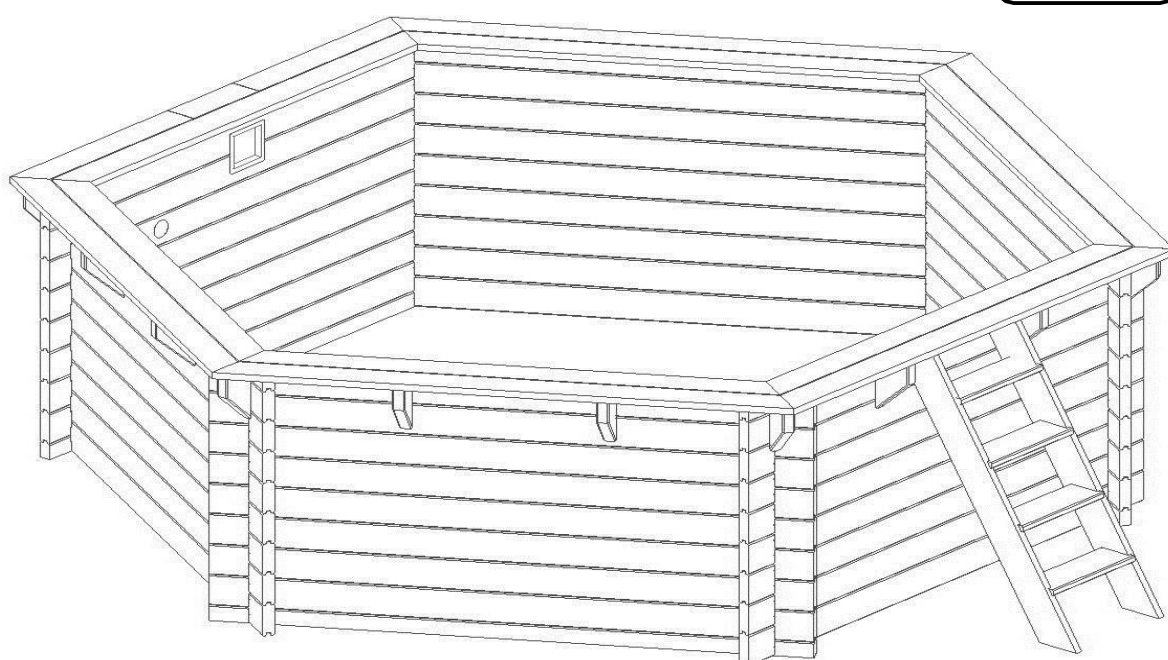



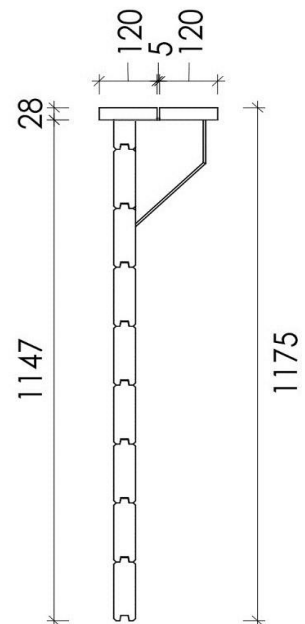
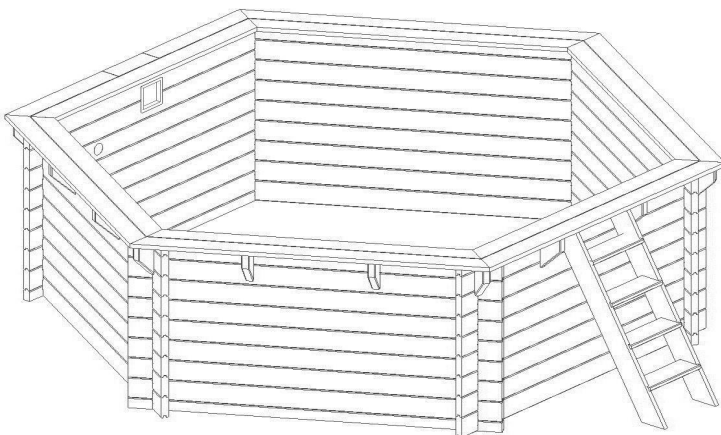
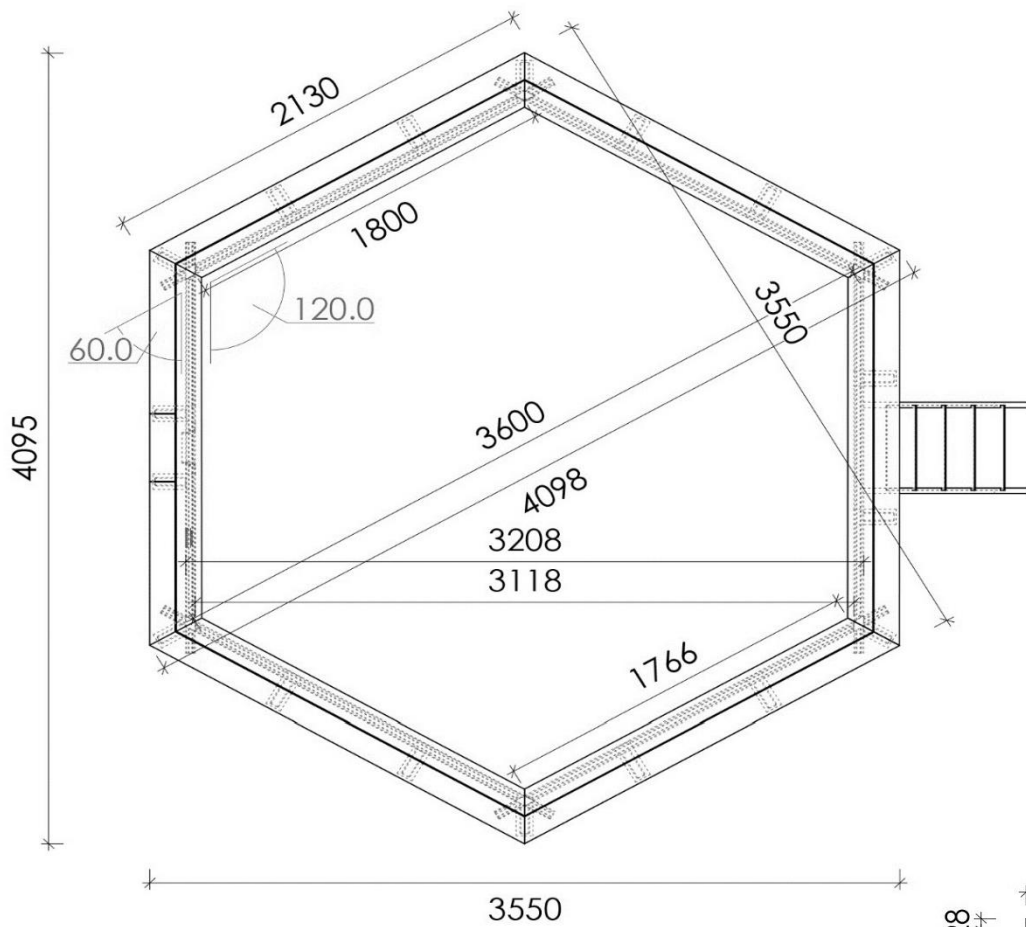
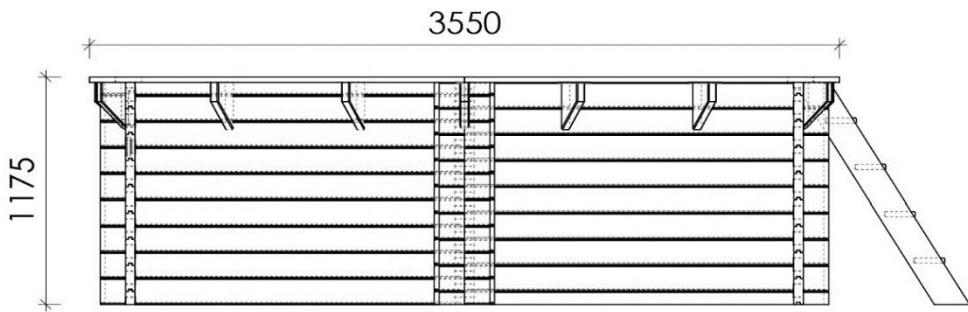

















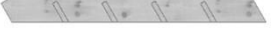



OKU Holzpool EMOTION-FUN Rund 4,10 Höhe 1,18 m Art. Nr.: 800400



OKU Holzpool EMOTION-FUN Rund 4,10 Höhe 1,18 m

Art. Nr. 800400

Nr	Artikel	Abmessung			Stück	A	B
		B	H	L			
1		28	120	2049	5		
2		28	120	1905	6		
3		28	120	847	2		
4		28	120	350	1		
5		44	145	2130	43		
6		44	135	2130	2		
7		44	78	2130	3		
8		44	67	2130	3		
9		44	135	2130	1		
10		44	145	2130	1		
11		44	145	2130	1		
12		28	145	1388	1		
13		28	145	1388	1		
14		28	145	440	4		
15	 	45	145	245	12		
16	 	45	145	245	6		
17		44	145	150	1		

Nr	Element	Abmessung	Stück	A	B
A		3,0x25	12		
B		3,5x25	228		
C		4,5x60	46		
D		5x100	48		
E		3x100x240	18		
F			2		
G		40x40	2		

Werkzeug

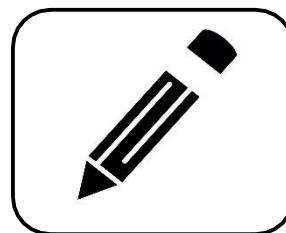
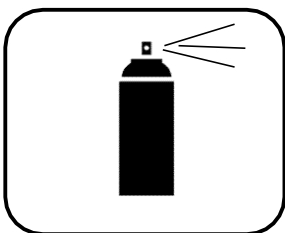
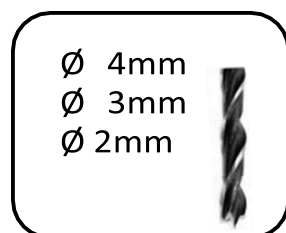
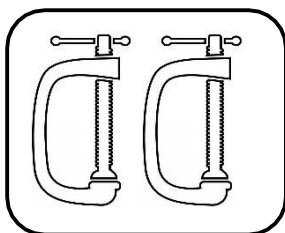
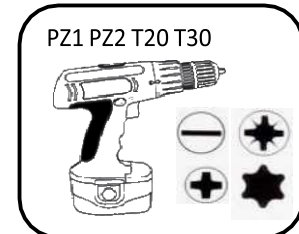
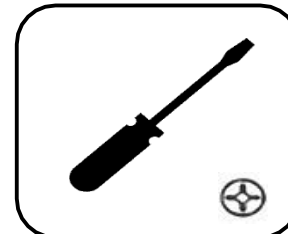
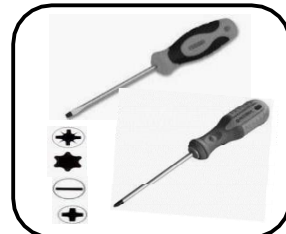
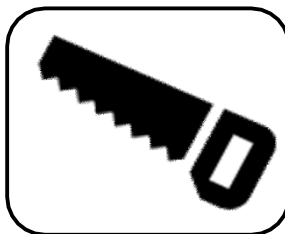
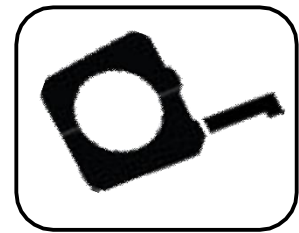
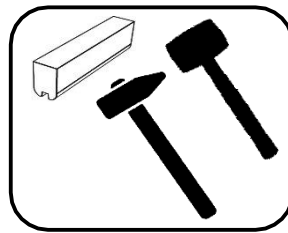
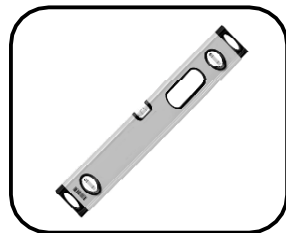
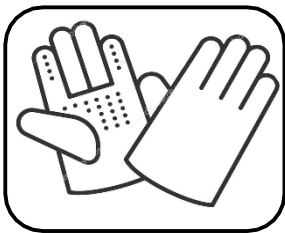

Wichtig!!!

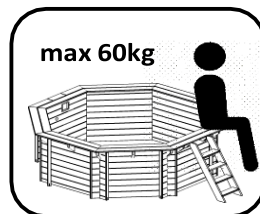
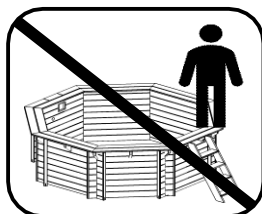
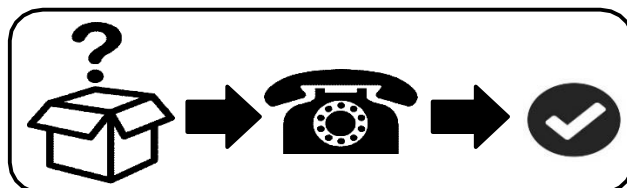
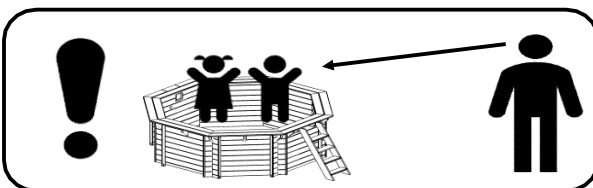
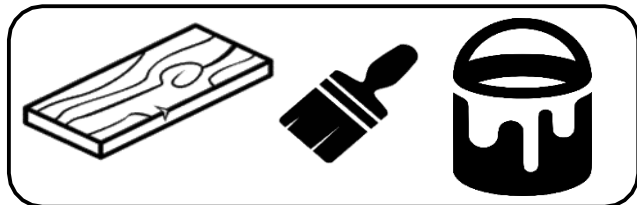
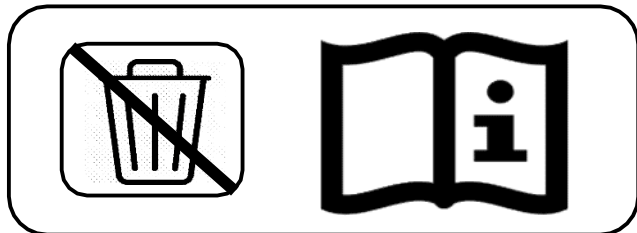
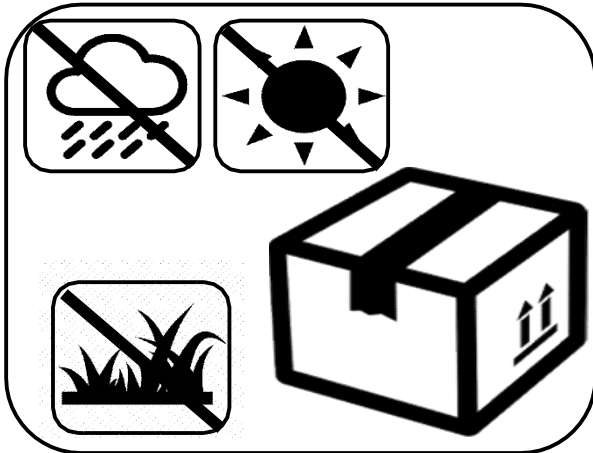
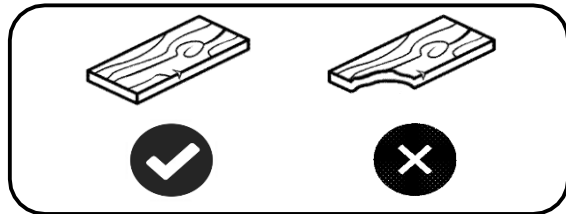
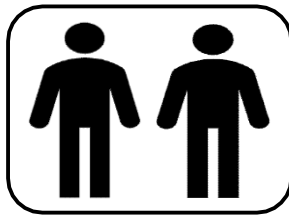

1. Der Holzpool sollte nicht unter oberirdischen Installationen wie Strom, Wasser und Gas installiert werden. Zudem sollte der Pool an einem Ort positioniert werden, welcher der Belastung des Pools standhält. Dafür **nicht** geeignet sind beispielsweise Balkone und Terrassen. Bei Missachtung dieser Vorgaben, kann es zu Schäden kommen.
2. Das Produkt sollte an einem Ort montiert werden, an dem es nicht in ständigem Kontakt mit Wasser ist (eingeschlossen der Sprinkleranlage).
3. Erkundigen Sie sich, bei der für Ihren Wohnsitz zuständigen Stelle, welche Bauvorschriften für das von Ihnen erworbene Produkt gelten.
4. Führen Sie die Fundamentarbeiten gemäß den Richtlinien dieses Handbuchs durch. Denken Sie daran, dass die Vorbereitung des Untergrunds entsprechend der Baupraxis erfolgen muss (Planen Sie die Zeit für die Trocknung des Betons mit ein).

Umgebung

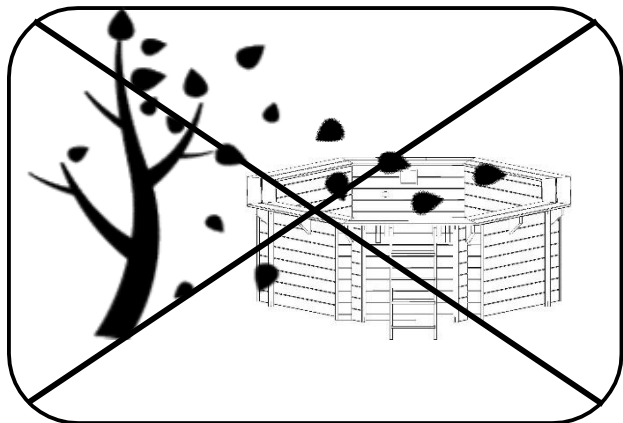
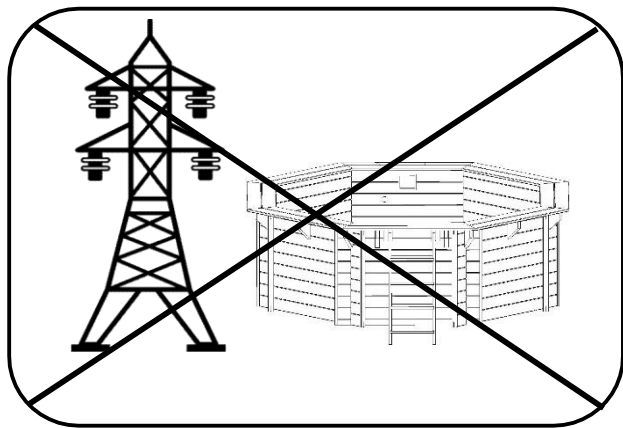
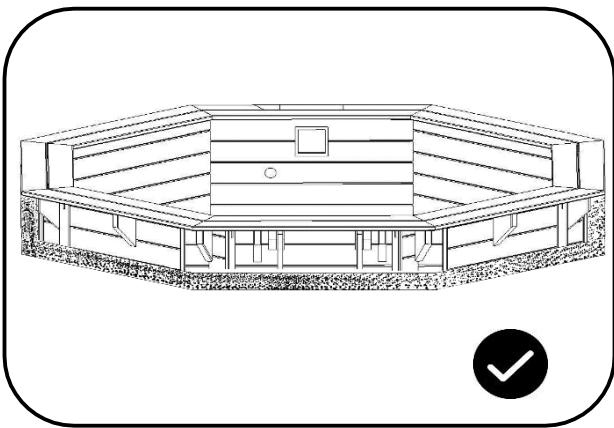
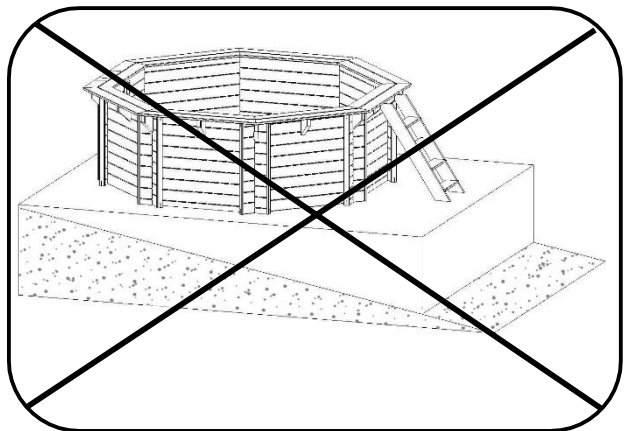
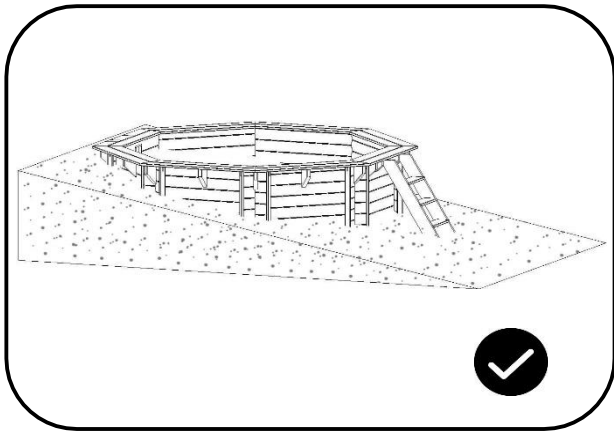
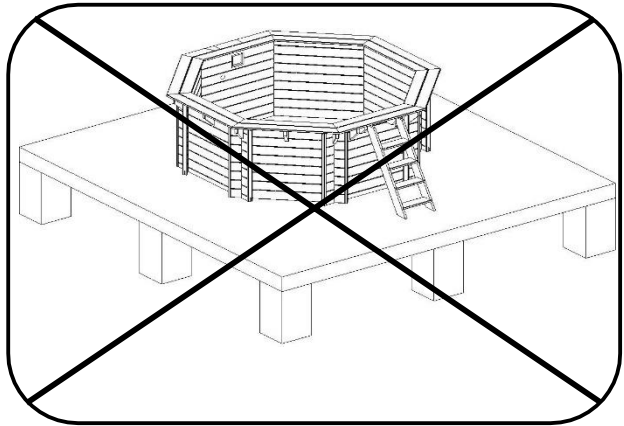
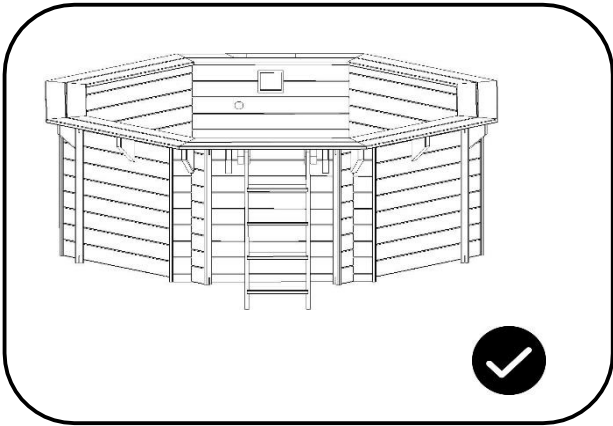

Positionierung der Poolwände:

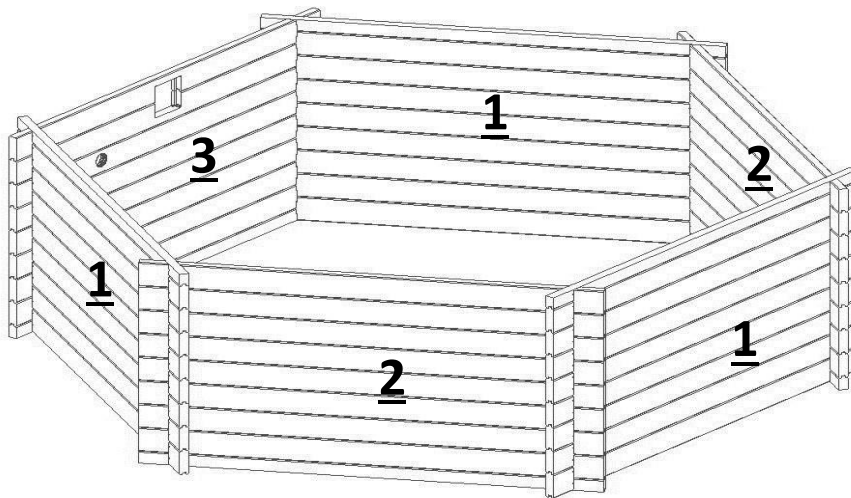

1 3x

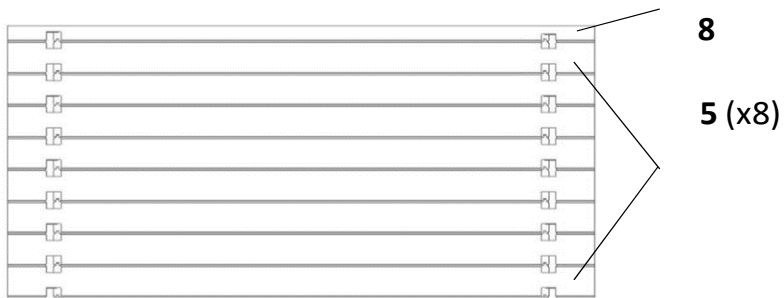

2 2x

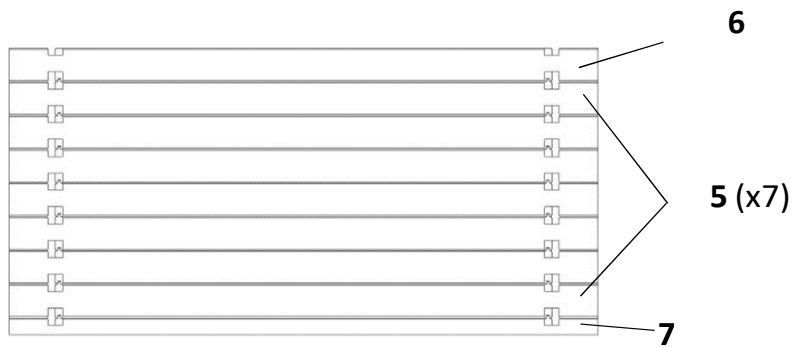

3

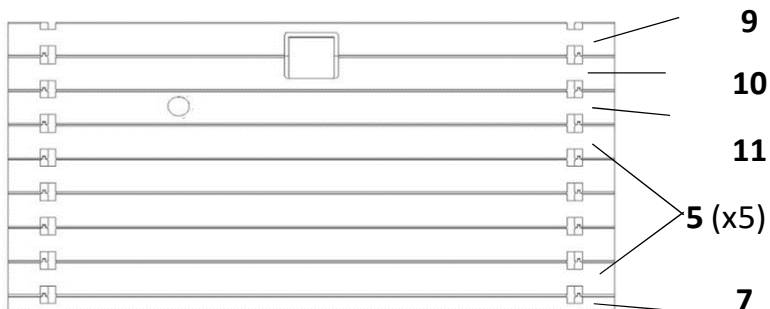

Betonfundament:

1. Der Standort für die Aufstellung des Schwimmbeckens muss mit Sorgfalt ausgewählt werden. Die Fläche muss eben, nivelliert und fest sein. Eine Betonplatte ist am besten geeignet, bei dieser die Betonklasse nicht weniger als C25 / 30, Expositionsklasse XC2 betragen darf.



2. Die Gesamtdicke der Betonplatte muss mindestens 10 cm betragen, wobei:
 - mindestens 5 cm über den Boden hinausragen muss - damit das Becken nicht im Wasser steht
 - mindestens 5 cm in den Boden eingelassen sein muss
3. Die Metallstützen müssen nach den im Handbuch angegebenen Richtlinien betoniert werden.
4. Die Betonplatte muss an die Topografie angepasst werden.
5. Die Vorbereitung des Standorts muss mit der exakten Festlegung der Abmessungen des Schwimmbeckens plus 10 cm mehr festgelegt werden. Sie sollten auch die Entfernung zu Strom und Wasser berücksichtigen. Es wird empfohlen, das Schwimmbecken an einem sonnigen Ort aufzustellen.

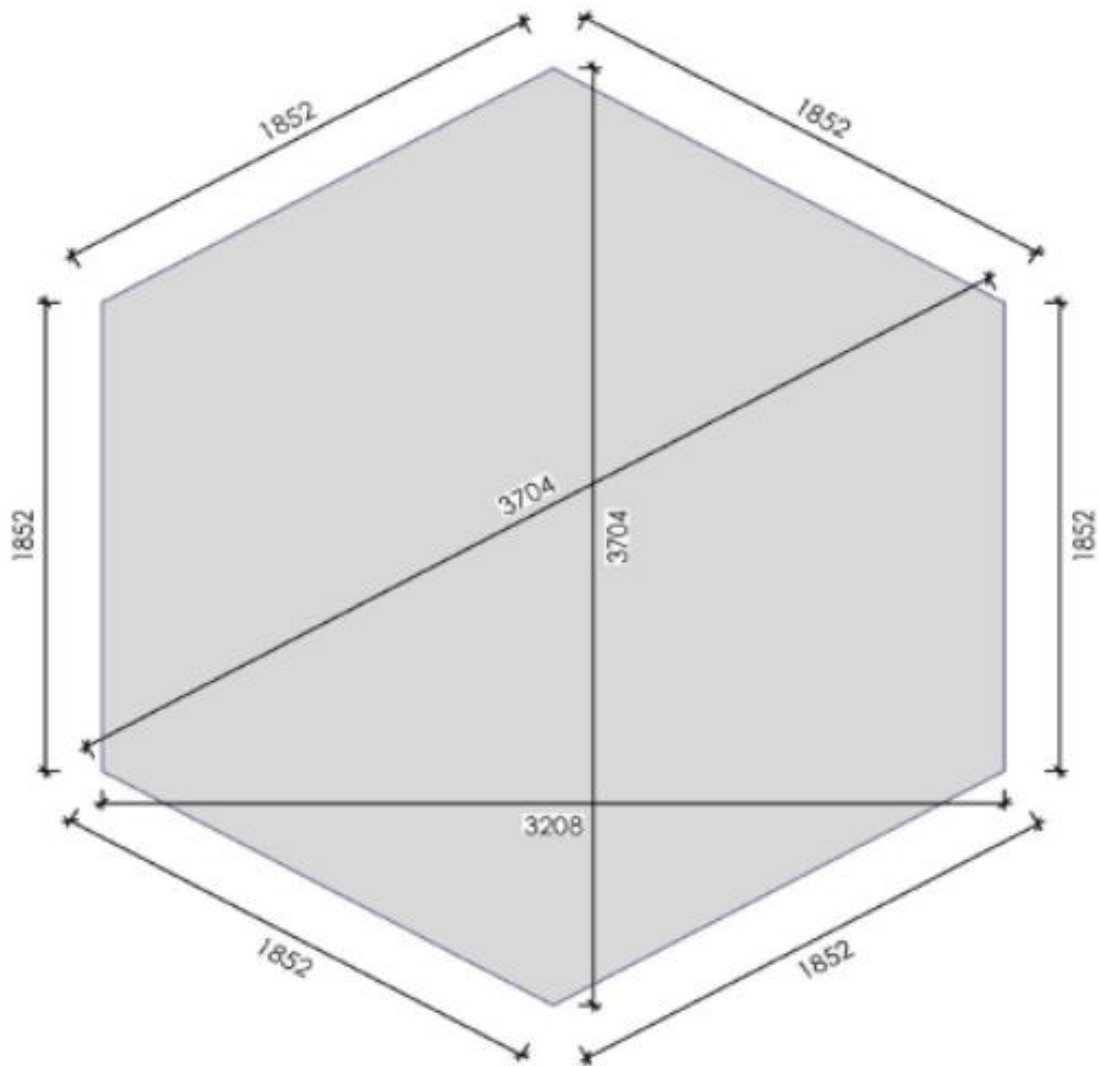
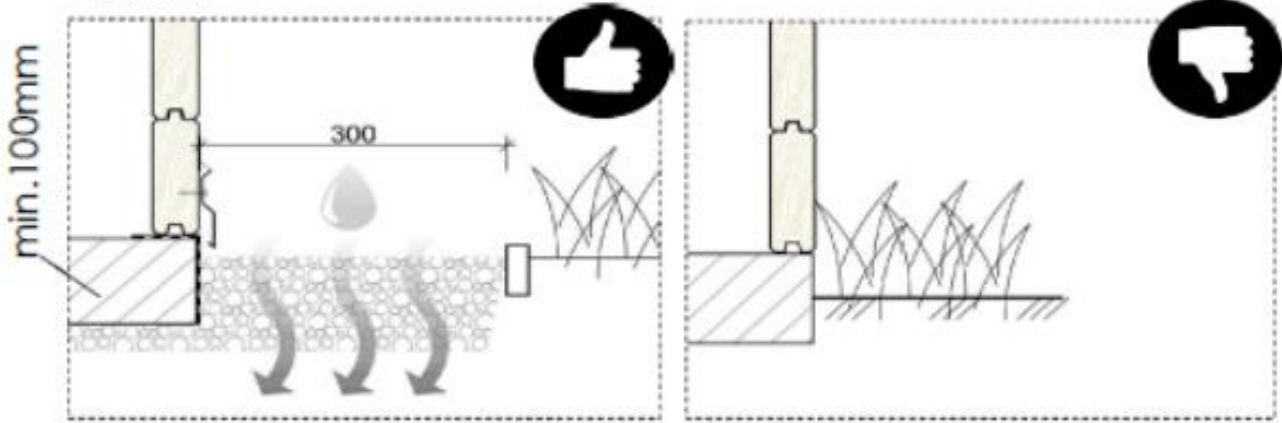

Pool in der Erde verbauen:

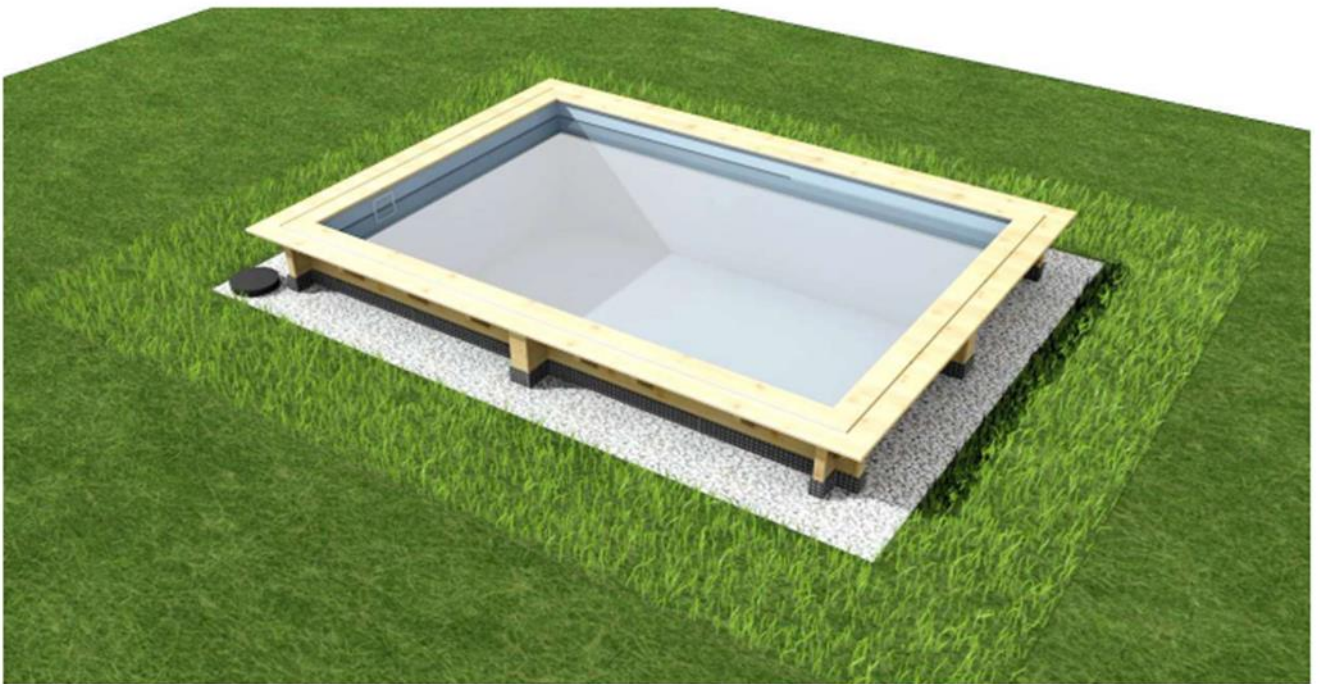
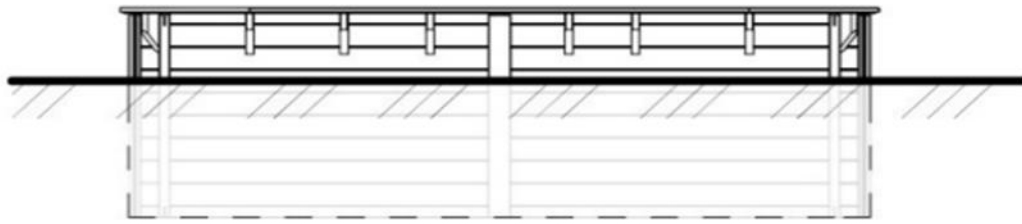

1

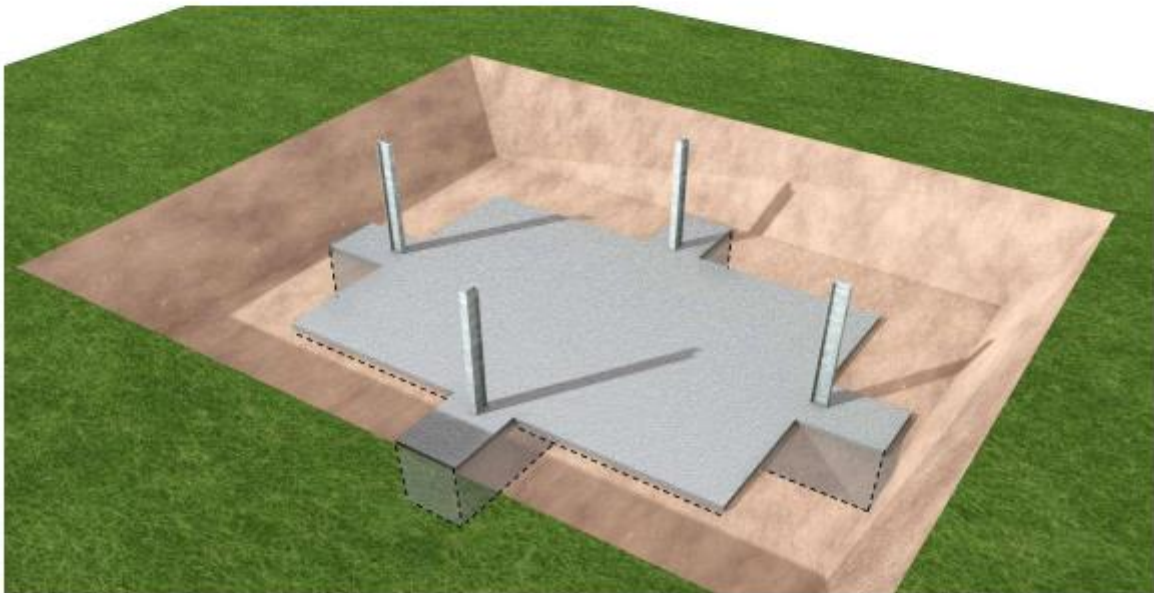
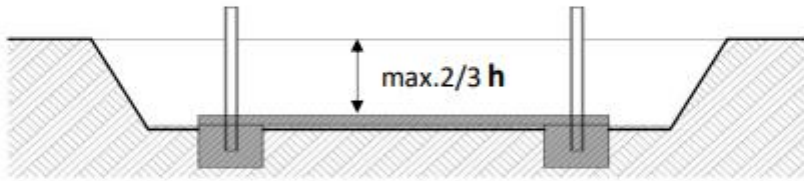
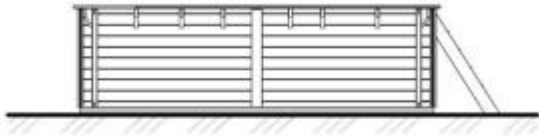
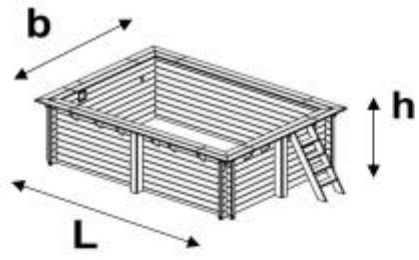

2

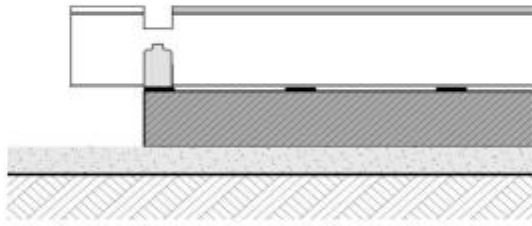
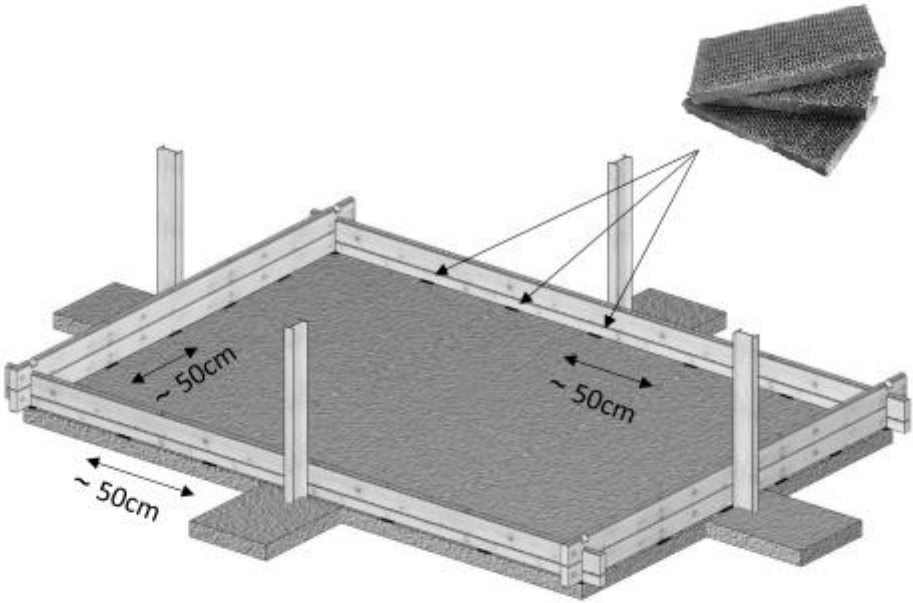

Um die Beckenwand von Schäden zu schützen, muss diese mit einer Noppenfolie eingehüllt werden.

3

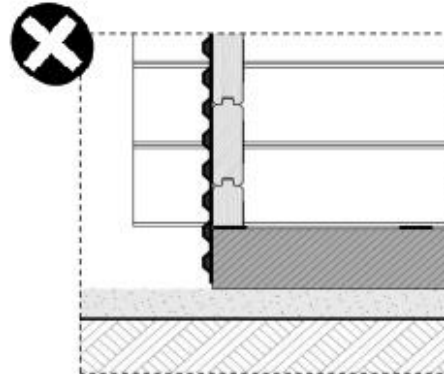
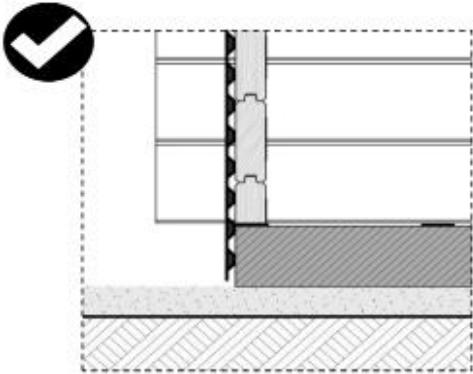
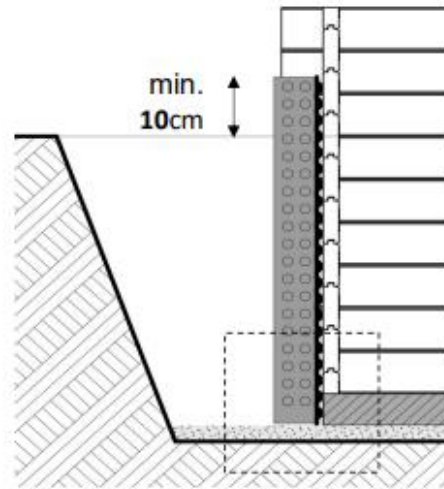

Verwenden Sie zur Entwässerung Drainagerohre mit einem Durchmesser von mindestens 10 cm.
Wenn der Boden Wasserundurchlässig ist, muss dieser durch groben Kies ersetzt werden.

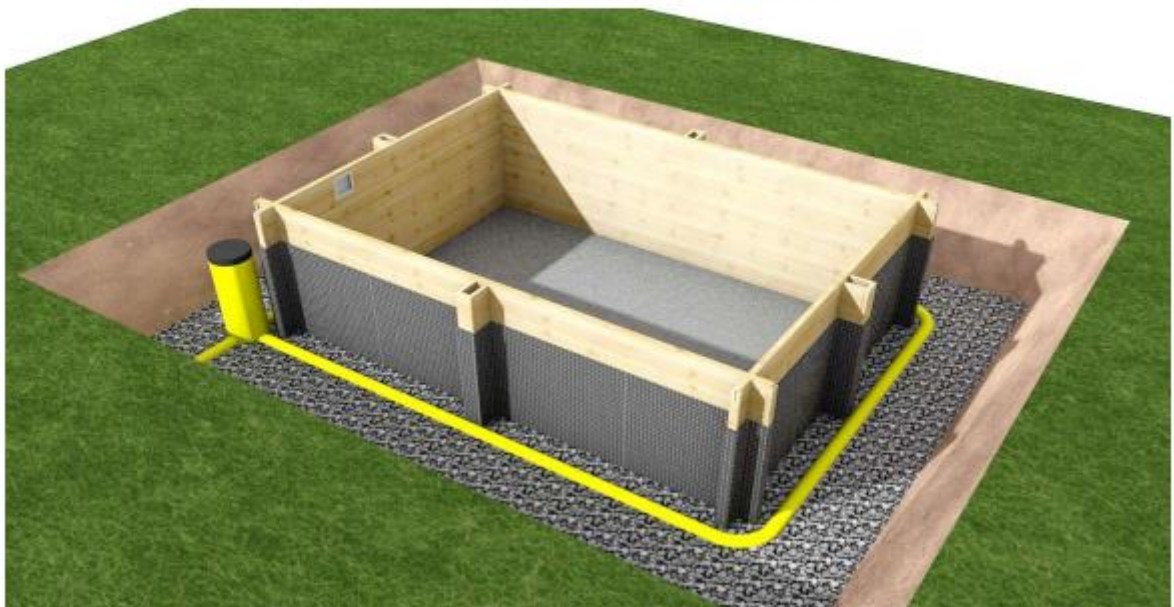
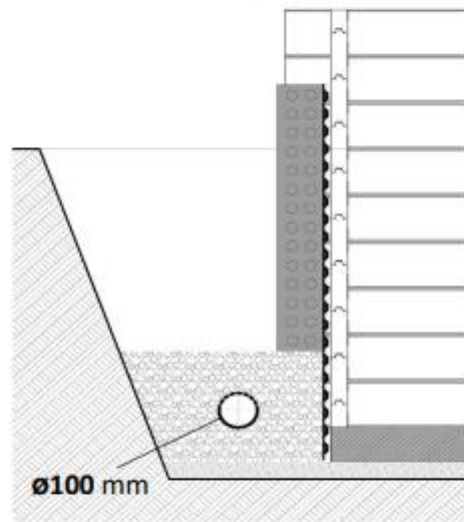
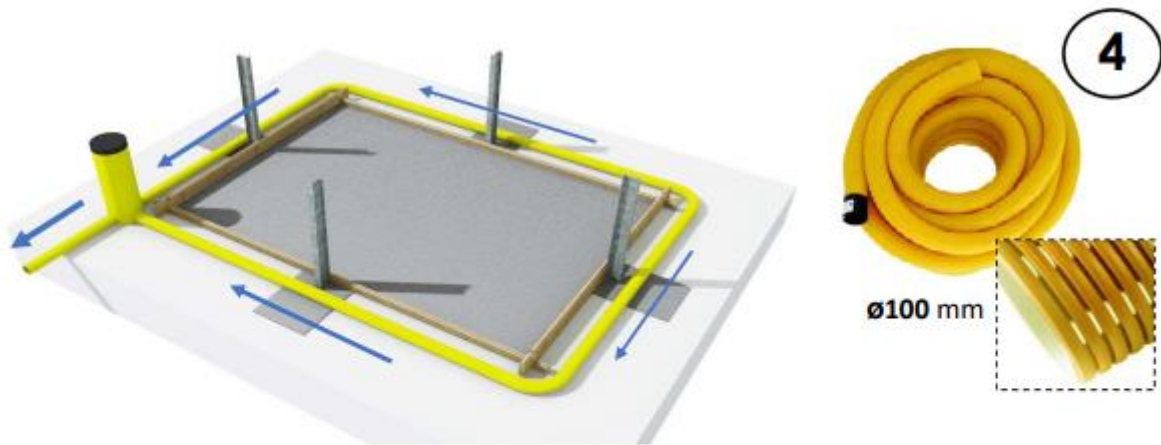

5

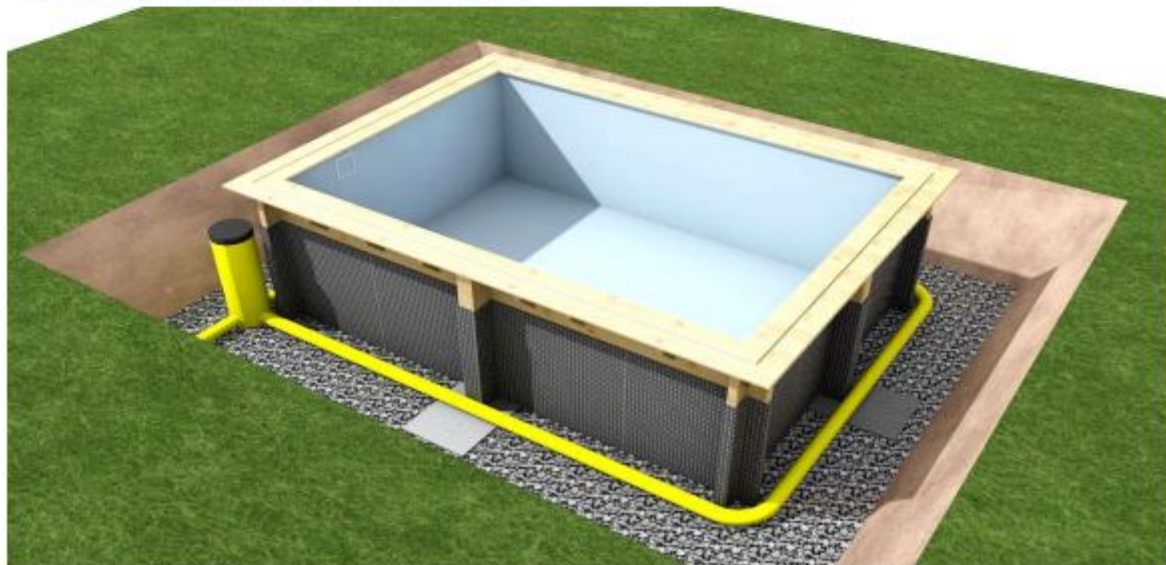
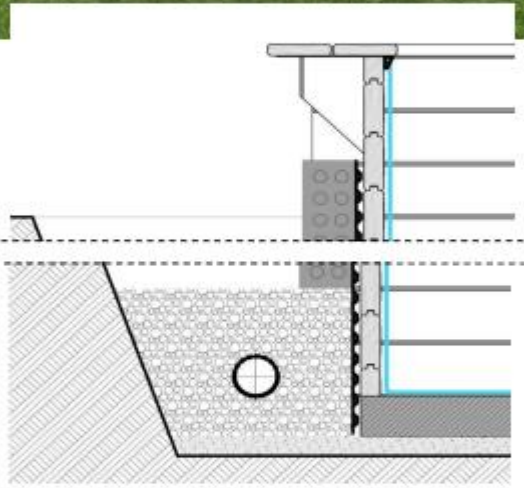

Die Grube, worin sich das Becken befindet, muss gleichmäßig mit dem Anstieg des Wasserspiegels befüllt werden.

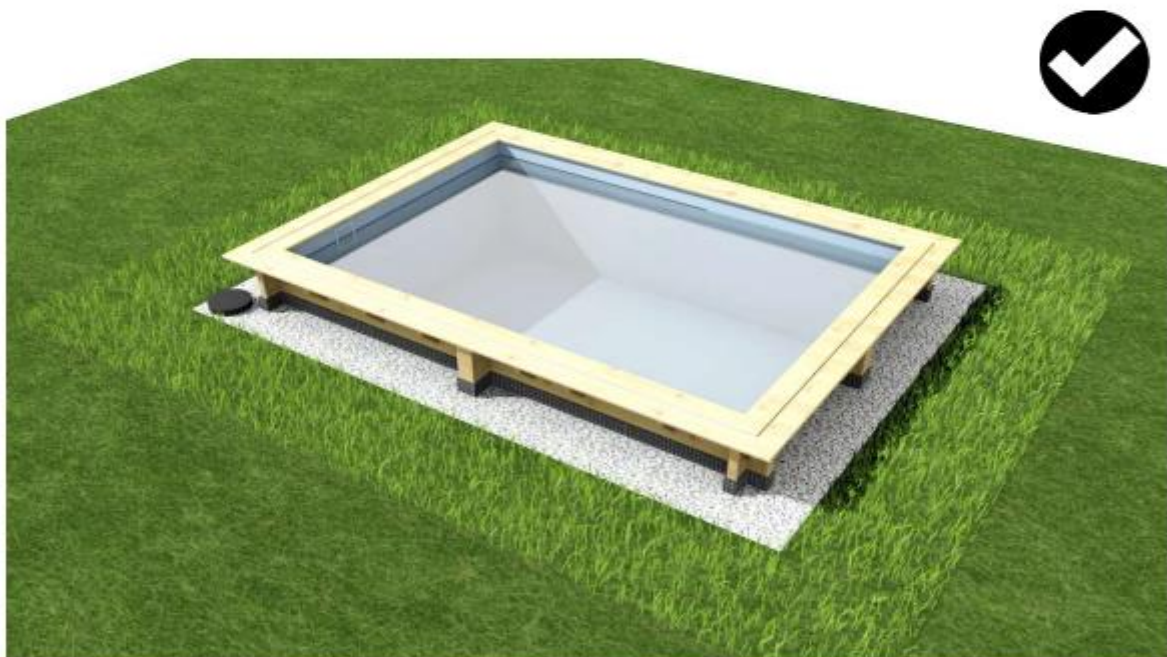
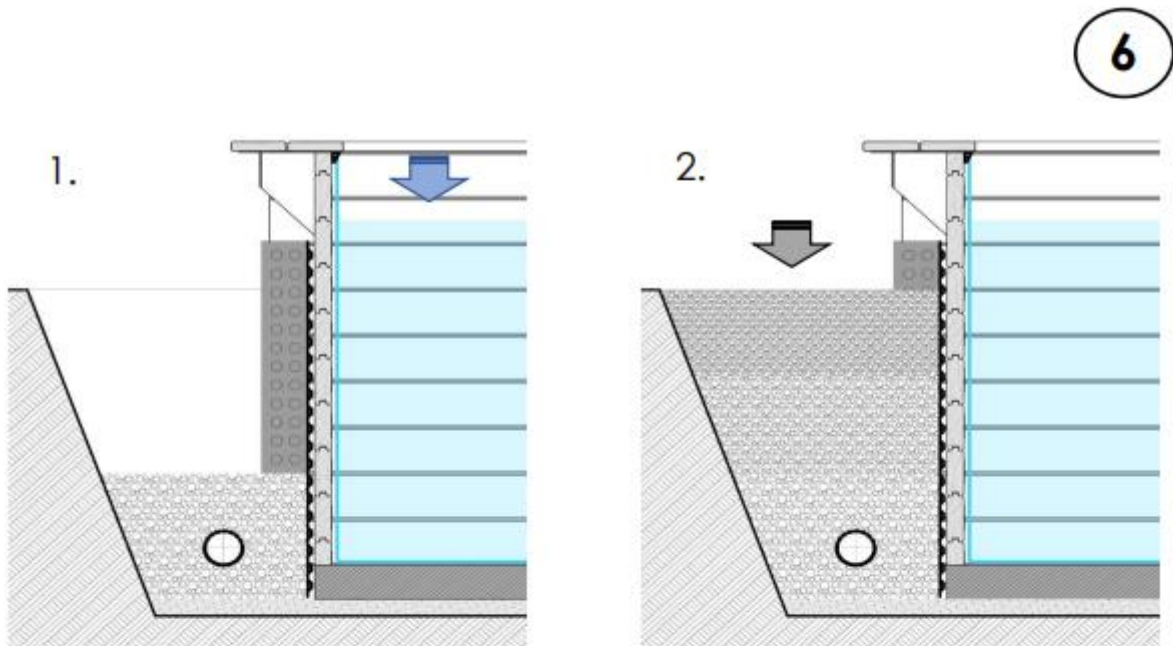

Beim Einwintern Ihres Holzpool's ist darauf zu achten das der Pool ca. bis zur Hälfte mit Wasser befüllt bleibt.

1

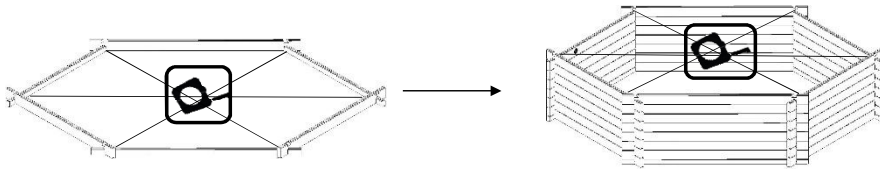
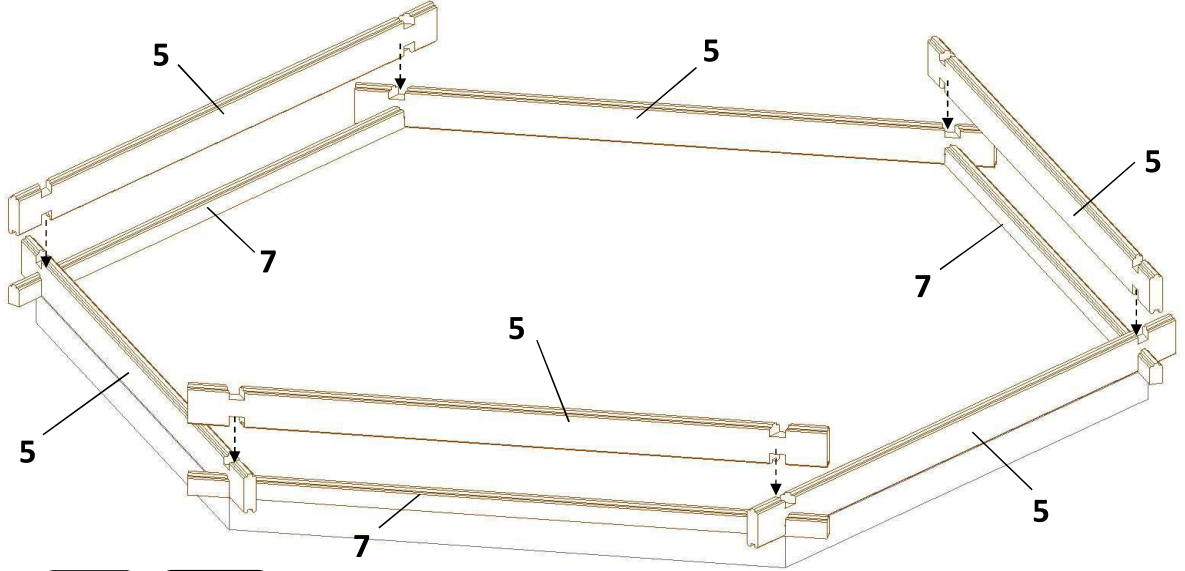
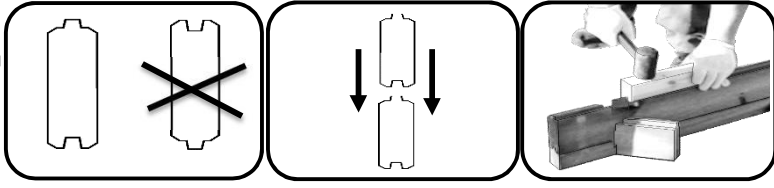

2

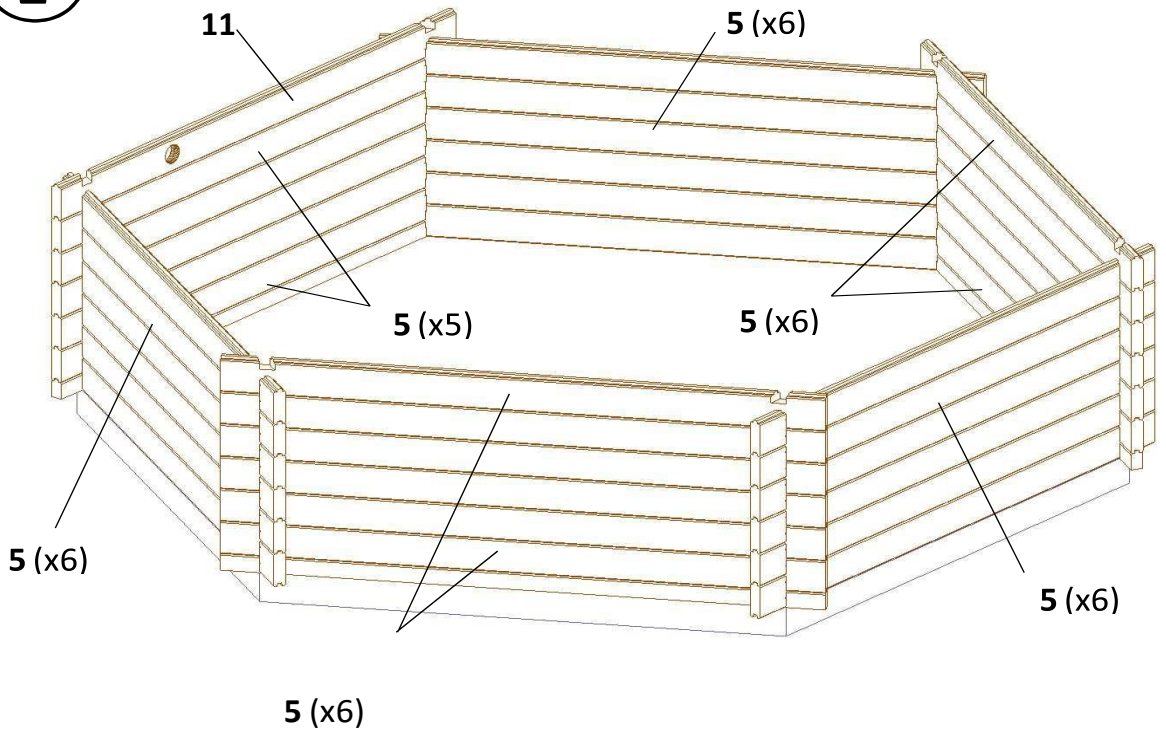

3

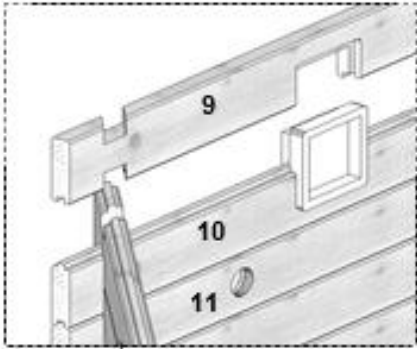

Ø4,0x40 (x6)



+ Ø4,0x40 (x16)

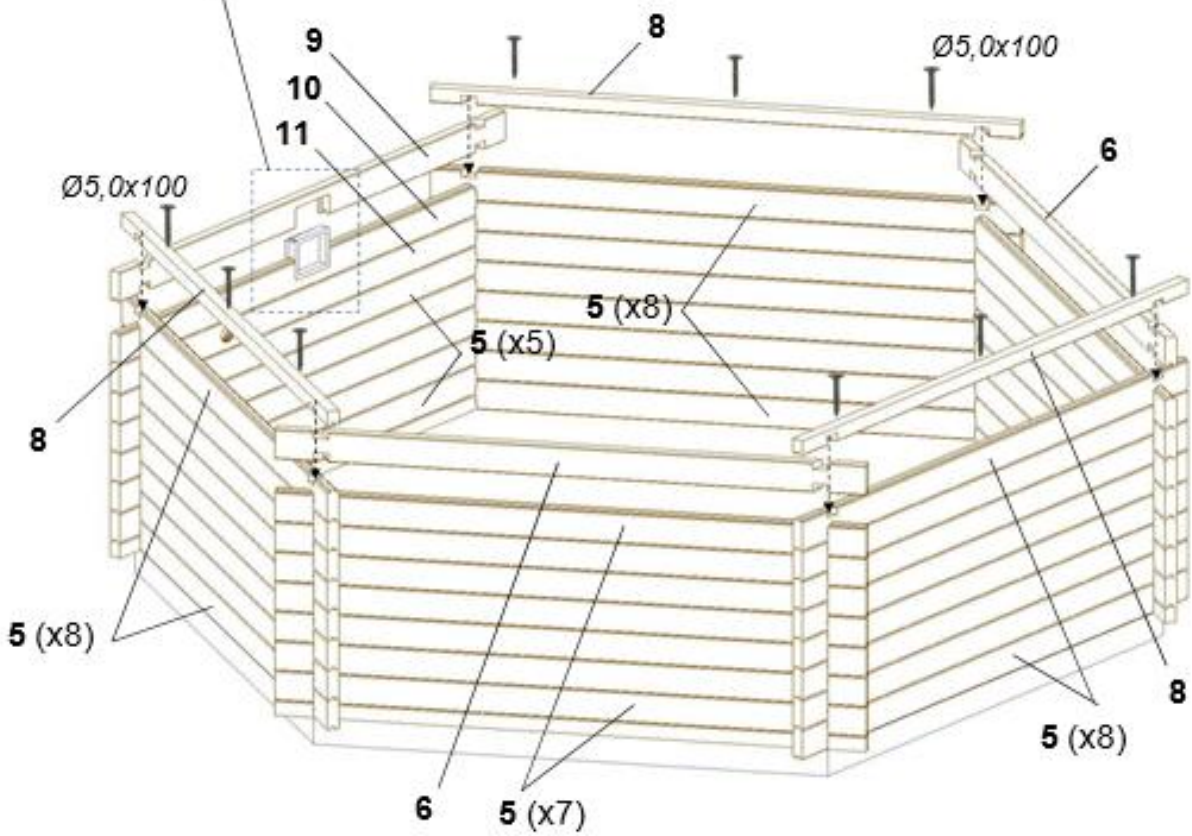

4

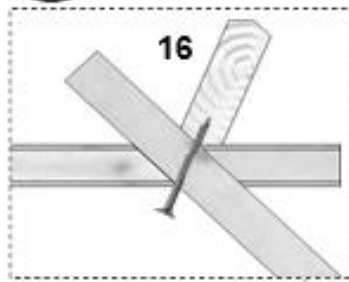

Ø5,0x100 (x2)



50
150
Ø5,0x100

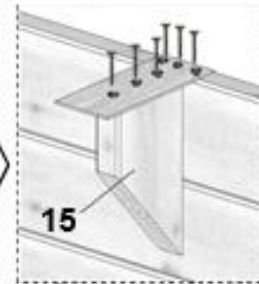

Ø3,5x25 (x6)

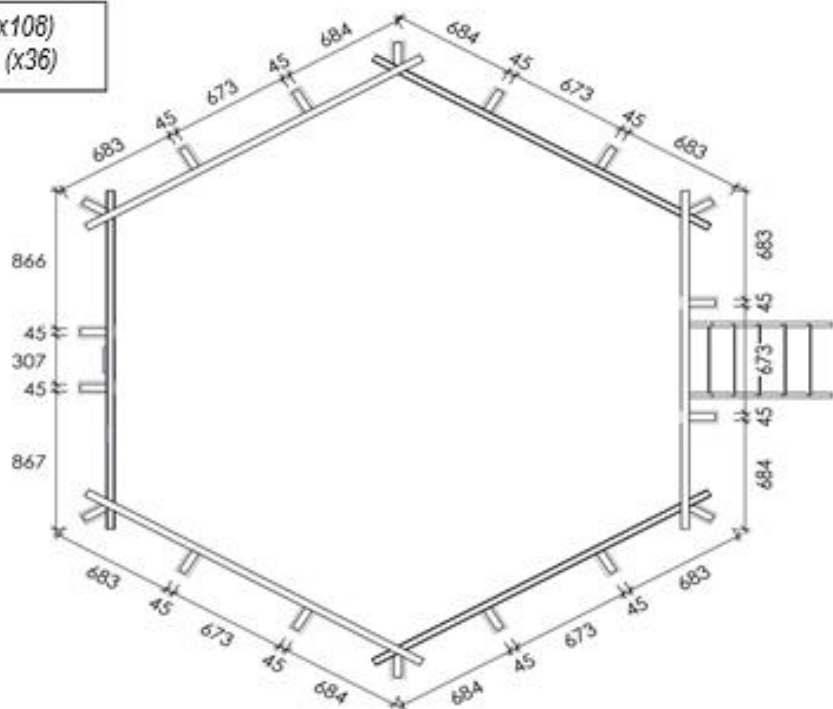
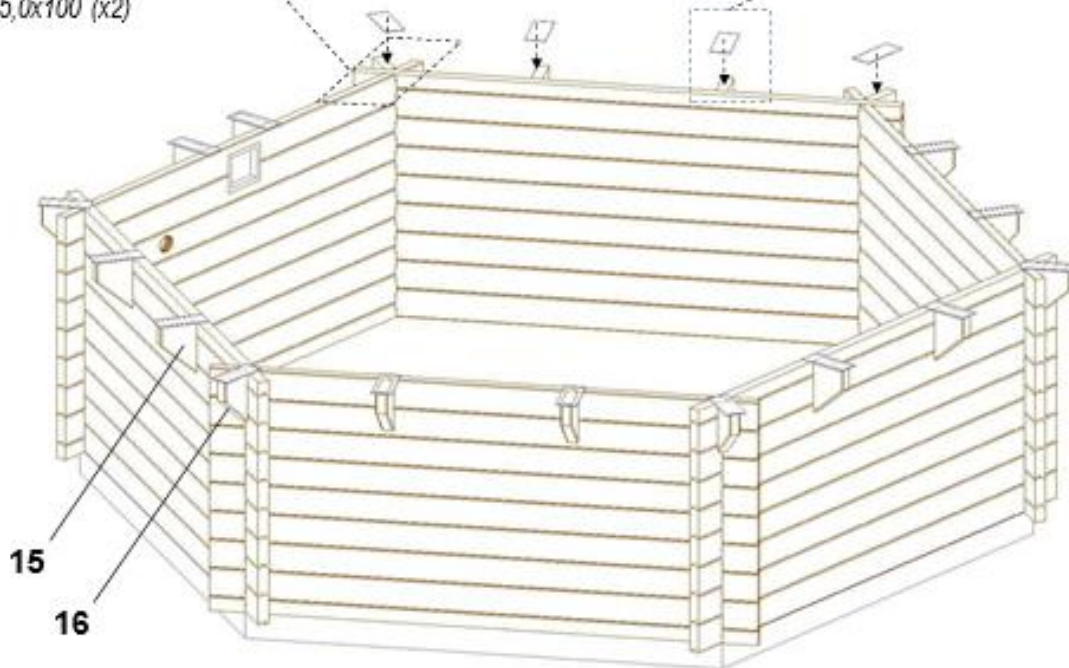

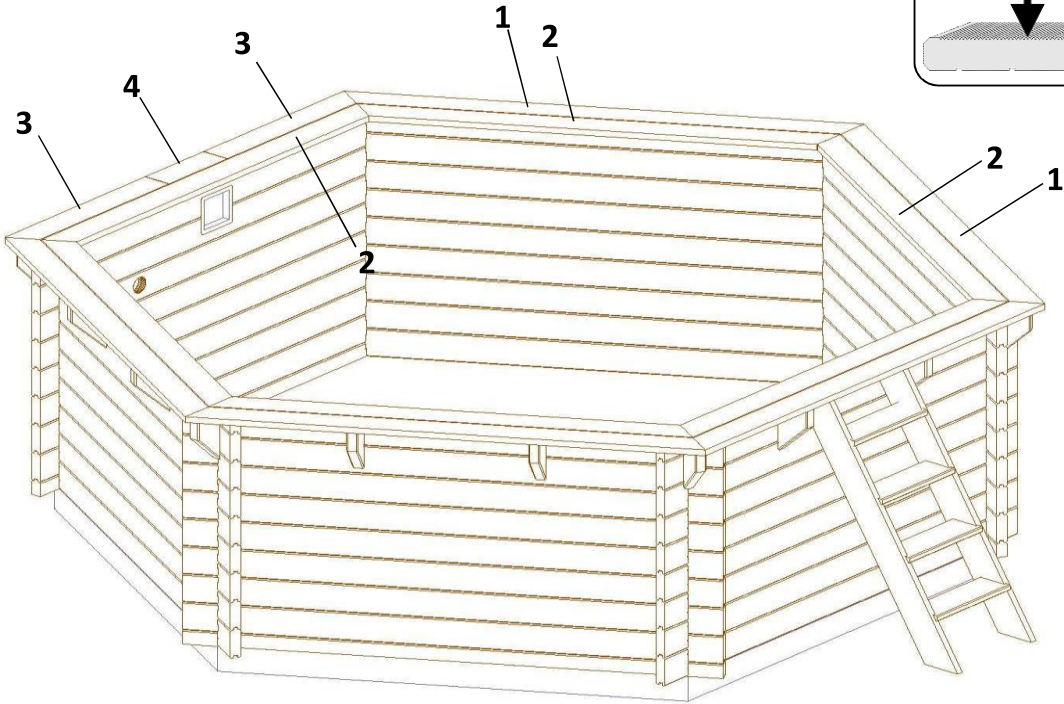
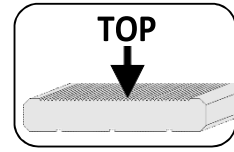

5



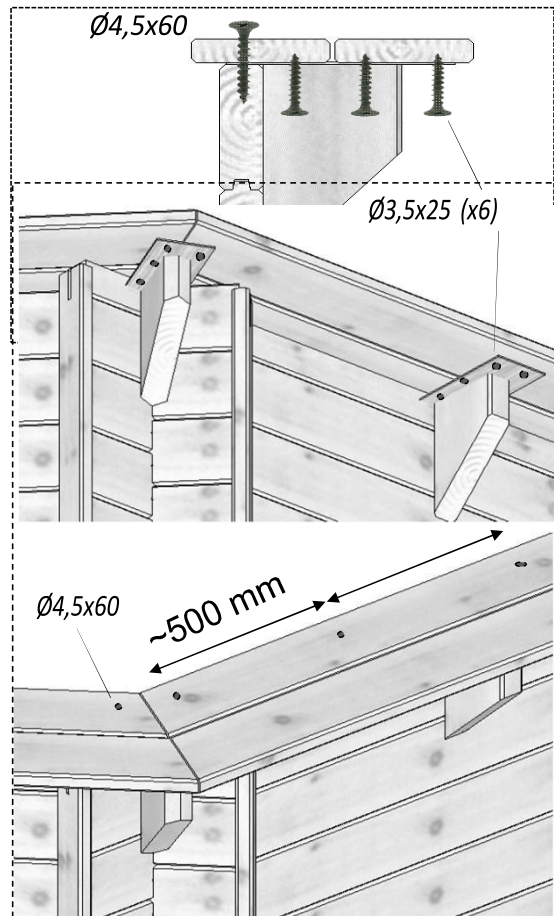

Ø3,0x25 (x6)

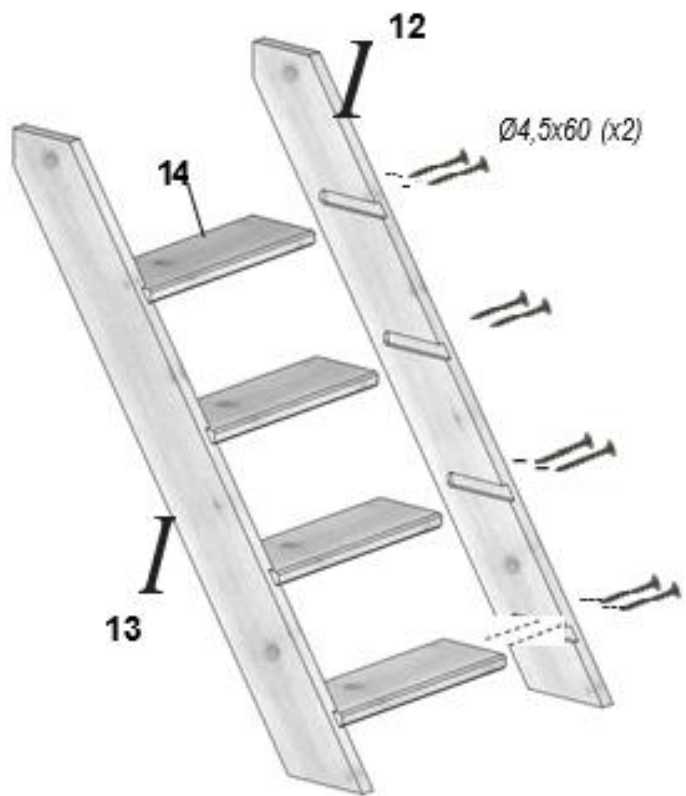
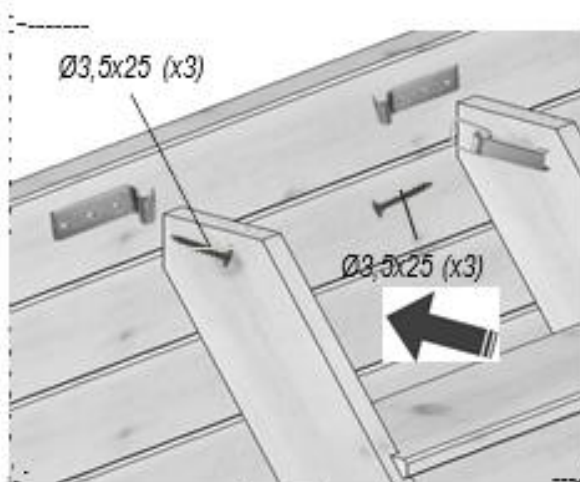

-  Ø3,0x25 (x12)
-  Ø3,5x25 (x104)
-  Ø4,5x60 (x30)

6



	$\varnothing 3,5 \times 25$ - x12
	$\varnothing 4,5 \times 60$ - x16